

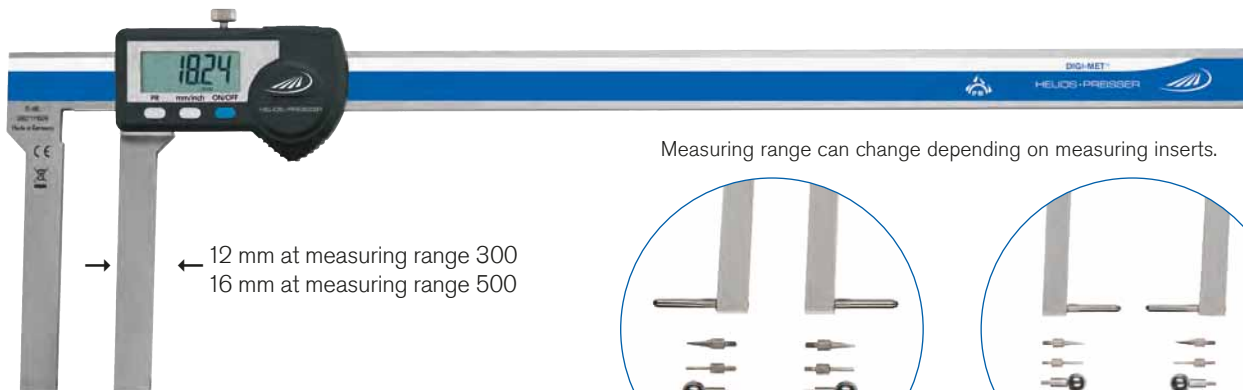

1348 DIGI-MET® Universal calipers



→ ← 12 mm at measuring range 300
16 mm at measuring range 500

Measuring range can change depending on measuring inserts.

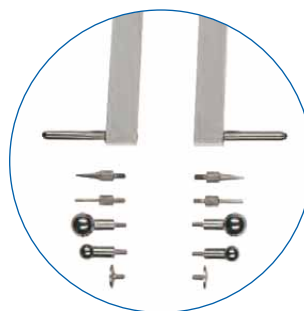

for internal measurements

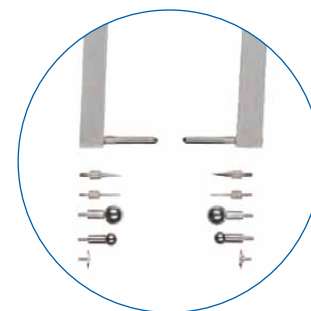

for external measurements

Model

- Stainless steel
- Factory standard
- Protection class IP65
- LCD display 10 or 12.5 mm
- Locking screw
- For internal and external measurements
- Individually adaptable on problematic tasks through measuring inserts with thread M 2.5

Functions

- ON / OFF
- **Quick-Start**
- **Quick-Lock** (key lock)
- Set to zero at any point
- mm / inch switching
- PRESET-Function (setting a numerical value)
- Variable data output RS 232 + Digimatic + USB

Delivery

- Wooden box
- Without measuring inserts (correct measuring inserts with thread M 2.5 see pages 125 - 128)

✕	Measuring range		Jaw length		Reading		Error limit	Order no.	List price EUR
	mm	inch	mm	inch	mm	inch	mm		
	0 - 300	0 - 12	90	3.5	0.01	.0005	0.06	1348 722	607.00
	0 - 500	0 - 20	100	4.0	0.01	.0005	0.06	1348 728	778.00



1998720 1998501 1997501

Accessories

	Order no.	List price EUR
Battery, 3V-Lithium, CR 2032	0220 704	3.90
Data cable DATA VARIABLE to RS232	1997 501	50.00
Data cable DATA VARIABLE to digimatic	1998 501	64.00
Data cable DATA VARIABLE to USB	1998 720	72.00



HELIOS · PREISSER

1326 Universal pocket caliper „Pocket Talent“



1

Incl. setting standard

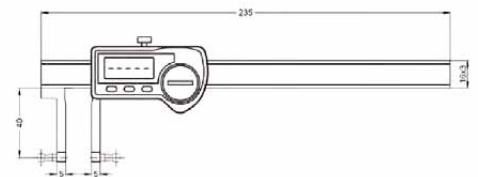

Model

- Stainless steel
- Protection class IP67
- Factory standard
- LCD display 7.5 mm
- Locking screw
- For internal and external measurements
- Individually adaptable on problematic tasks through measuring inserts with thread M 2.5

Functions

- ON / OFF
- **Quick-Start**
- **Quick-Lock** (key lock)
- Set to zero at any point
- mm / inch switching
- PRESET-Function (setting a numerical value)
- Variable data output RS 232 + Digimatic + USB

Delivery

- Wooden box
- Measuring inserts No. 0710161* and 0710177*
Planar surface Ø 4.8 mm /
Ball inserts Ø 5.0 mm
- Setting standard

Measuring range	Measuring range		Jaw length	Reading		Order no.	List price
	mm	inch		mm	mm		
0 - 150	0 - 6	40	0.01	.0005	1326 932	359.00	

Our all-round talent can be combined with all common types of measuring inserts for indicators with a standard M 2.5 thread. This way, the Pocket Talent offers you various solutions for numerous measurement applications.

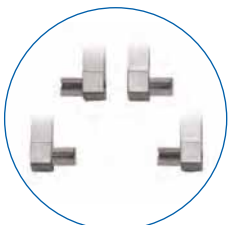

0710161*

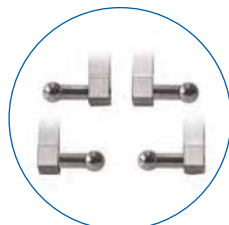

0710177*

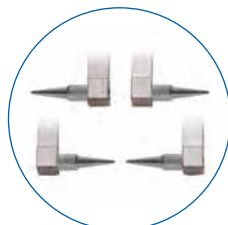

0710166

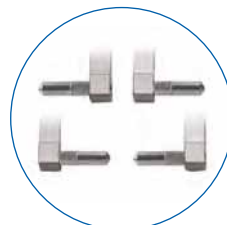

0710167



0710163



1998720



1998501



1997501

Accessories

Accessories	Order no.	List price
		EUR
Battery, 3V-Lithium, CR 2032	0220 704	3.90
Measuring inserts M 2.5	0710 161	4.30
Measuring inserts M 2.5	0710 163	6.50
Measuring inserts M 2.5	0710 166	5.90
Measuring inserts M 2.5	0710 167	4.10
Measuring inserts M 2.5	0710 177	8.20
Setting standard for Pocket Talent	1326 990	39.00
Data cable DATA VARIABLE to RS232	1997 501	50.00
Data cable DATA VARIABLE to digimatic	1998 501	64.00
Data cable DATA VARIABLE to USB	1998 720	72.00



Product video



1326 DIGI-MET® Pocket calipers for specific measuring tasks

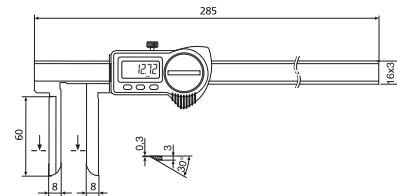
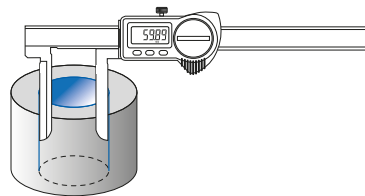
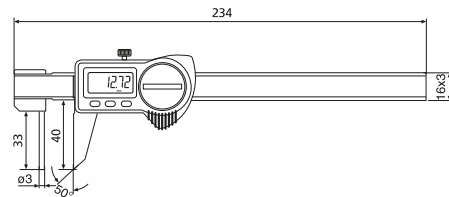
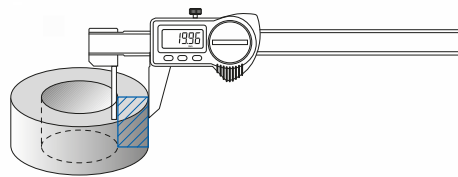
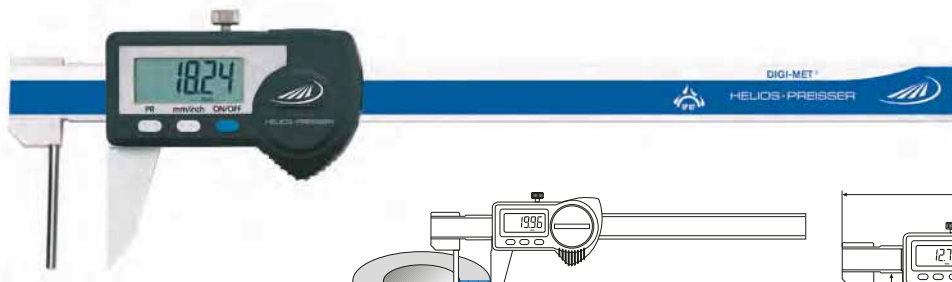

Model

- Protection class IP67
- Stainless steel
- LCD display 7.5 mm
- Factory standard
- Measuring system is insensitive to cooling agents and dust

- Housing and operating keys have an excellent chemical resistance
- Inside cross points
- Locking screw

Functions

- ON / OFF
- Quick-Start
- Quick-Lock (key lock)
- Set to zero at any point
- mm / inch switching
- PRESET-Function (setting a numerical value)
- Variable data output RS 232 + Digimatic + USB

Delivery

- Wooden case

Icon	Measuring range		Jaw length		Reading		Order no.	List price EUR
	mm	inch	mm	inch	mm	inch		
Wall thickness caliper								
	0 - 150	0 - 6	40	1.6	0.01	.0005	1326 918	503.00
With long cross jaws for inner measurements								
	10 - 200	0.4 - 8	60	2.4	0.01	.0005	1326 930	653.00

Accessories



1998720 1997501 1998501

Accessories	Order no.	List price EUR
Battery, 3V-Lithium, CR 2032	0220 704	3.90
Data cable DATA VARIABLE to RS232	1997 501	50.00
Data cable DATA VARIABLE to digimatic	1998 501	64.00
Data cable DATA VARIABLE to USB	1998 720	72.00



HELIOS · PREISSER

1326 DIGI-MET® Pocket calipers for specific measuring tasks

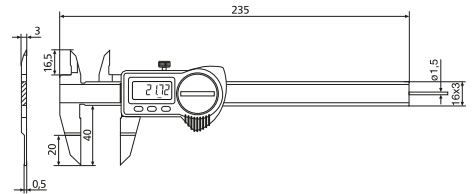
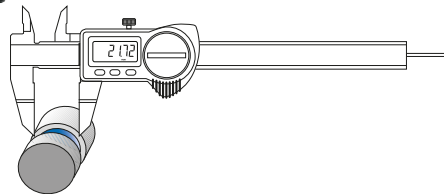
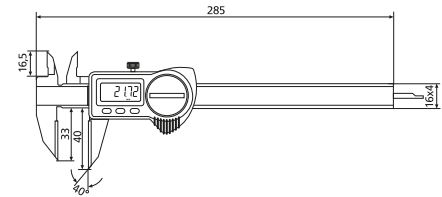
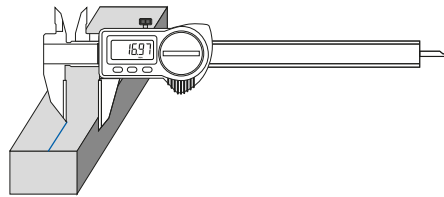
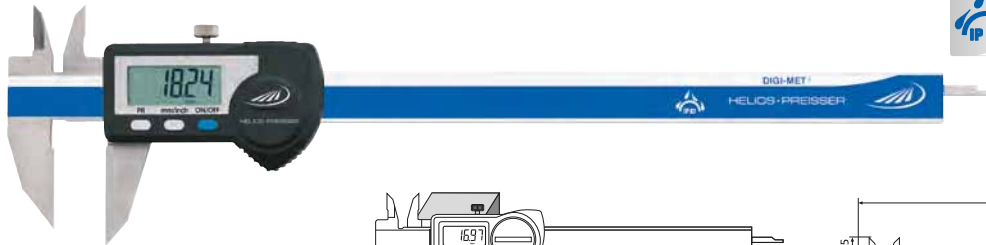

Model

- Protection class IP67
- Stainless steel
- LCD display 7,5 mm
- Factory standard
- Measuring system is insensitive to cooling agents and dust

- Housing and operating keys have an excellent chemical resistance
- Inside cross points
- Locking screw

Functions

- ON / OFF
- Quick-Start
- Quick-Lock (key lock)
- Set to zero at any point
- mm / inch switching
- PRESET-Function (setting a numerical value)
- Variable data output RS 232 + Digimatic + USB

Delivery

- Wooden case

Icon	Measuring range		Jaw length		Reading		Depth gauge	Order no.	List price EUR
	mm	inch	mm	inch	mm	inch			
Scribing caliper with carbide-tipped outer measuring surfaces									
	0 - 200	0 - 8	33	1.3	0.01	.0005	rectangular	1326 912	320.00
With flat measuring surfaces e.g. for outer recesses									
	0 - 150	0 - 6	40	1.6	0.01	.0005	round 1.5	1326 920	545.00

Accessories



1998720 1997501 1998501

Accessories	Order no.	List price EUR
Battery, 3V-Lithium, CR 2032	0220 704	3.90
Data cable DATA VARIABLE to RS232	1997 501	50.00
Data cable DATA VARIABLE to digimatic	1998 501	64.00
Data cable DATA VARIABLE to USB	1998 720	72.00



1326 DIGI-MET® Pocket calipers for specific measuring tasks

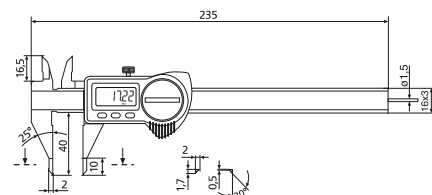
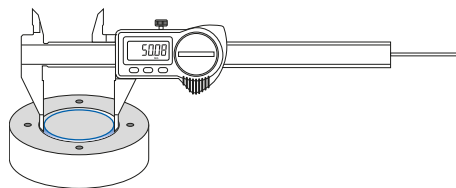
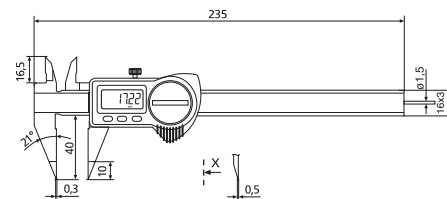
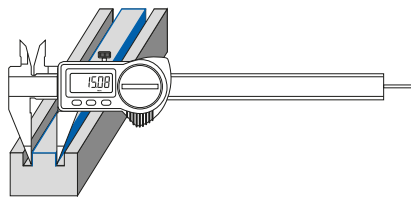

Model

- Protection class IP67
- Stainless steel
- LCD display 7.5 mm
- Factory standard
- Measuring system is insensitive to cooling agents and dust

- Housing and operating keys have an excellent chemical resistance
- Inside cross points
- Locking screw

Functions

- ON / OFF
- Quick-Start
- Quick-Lock (key lock)
- Set to zero at any point
- mm / inch switching
- PRESET-Function (setting a numerical value)
- Variable data output RS 232 + Digimatic + USB

Delivery

- Wooden case

Measuring range	Jaw length		Reading		Order no.	List price EUR
	mm	inch	mm	inch		
With pointed jaws						
0 - 150	0 - 6	40	1.6	0.01	.0005	1326 916 396.00
With fine measuring tips						
0 - 150	0 - 6	40	1.6	0.01	.0005	1326 922 447.00



1998720

1998501

1997501

Accessories

	Order no.	List price EUR
Battery, 3V-Lithium, CR 2032	0220 704	3.90
Data cable DATA VARIABLE to RS232	1997 501	50.00
Data cable DATA VARIABLE to digimatic	1998 501	64.00
Data cable DATA VARIABLE to USB	1998 720	72.00



HELIOS · PREISSER

1326 DIGI-MET® Pocket calipers for specific measuring tasks



1

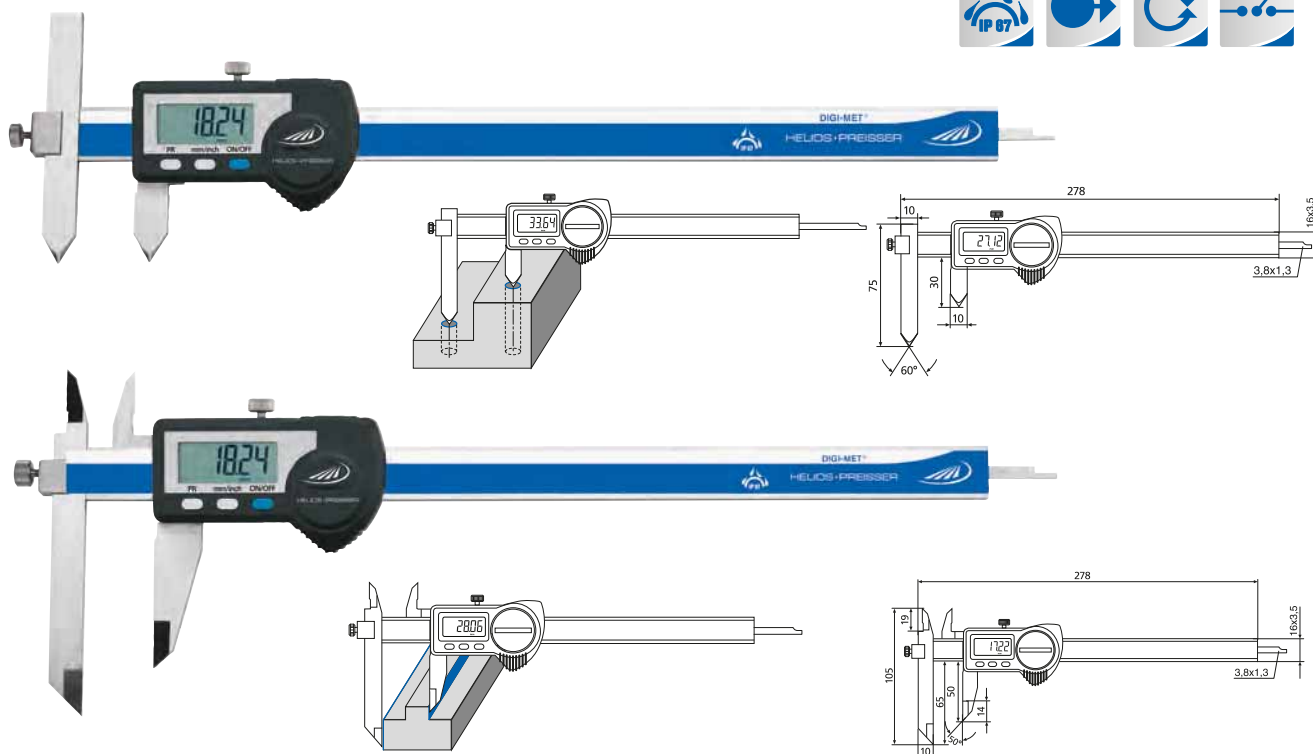

Model

- Protection class IP67
- Stainless steel
- LCD display 7.5 mm
- Factory standard
- Measuring system is insensitive to cooling agents and dust

- Housing and operating keys have an excellent chemical resistance
- Inside cross points
- Locking screw

Functions

- ON / OFF
- Quick-Start**
- Quick-Lock** (key lock)
- Set to zero at any point
- mm / inch switching
- PRESET-Function (setting a numerical value)
- Variable data output RS 232 + Digimatic + USB

Delivery

- Wooden case

Measuring range	Measuring range		Jaw length		Reading		Order no.	List price EUR
	mm	inch	mm	inch	mm	inch		
Moving jaws for measuring the distance between bores								
10 - 210	0.4 - 8.3	75	3.0	0.01	.0005	1326 924	443.00	
Moving jaws + cross tips								
0 - 200	0 - 8	65	2.5	0.01	.0005	1326 928	476.00	



1998720

1998501

1997501

Accessories

	Order no.	List price EUR
Battery, 3V-Lithium, CR 2032	0220 704	3.90
Data cable DATA VARIABLE to RS232	1997 501	50.00
Data cable DATA VARIABLE to digimatic	1998 501	64.00
Data cable DATA VARIABLE to USB	1998 720	72.00



1340 / 1341 DIGI-MET® Workshop calipers IP65



1340 522

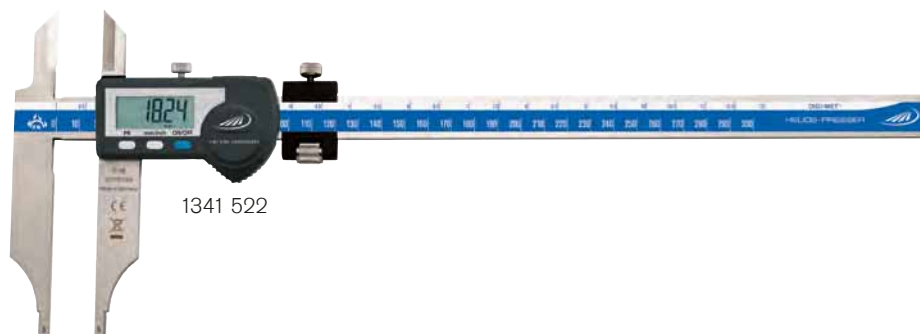

1341 522

Model

- Stainless steel
- Inductive measuring system, protection class IP65
- DIN 862
- Knife points
- LCD display:
 - 10 mm with measuring range 300 mm;
 - 12.5 mm from measuring range 500 mm
- Locking screw

Functions

- ON / OFF
- **Quick-Start**
- **Quick-Lock** (key lock)
- Set to zero at any point
- mm / inch switching
- PRESET-Function (setting a numerical value)
- Variable data output RS 232 + Digimatic + USB

Delivery

- Wooden case

✕	📏	Measuring range		Jaw length		Reading		Stepped jaws	Error limit	Order no.	List price EUR
		mm	inch	mm	inch	mm	inch	mm	mm		
With knife points, without fine adjustment											
▪		0 - 300	0 - 12	90	3.5	0.01	.0005	10	0.03	1340 522	431.00
▪		0 - 500	0 - 20	125	5.0	0.01	.0005	20	0.03	1340 528	822.00
▪		0 - 800	0 - 31	150	6.0	0.01	.0005	20	0.04	1340 532	1110.00
▪		0 - 1000	0 - 39	150	6.0	0.01	.0005	20	0.04	1340 534	1365.00
With knife points, with fine adjustment											
▪		0 - 300	0 - 12	90	3.5	0.01	.0005	10	0.03	1341 522	488.00
▪		0 - 500	0 - 20	125	5.0	0.01	.0005	20	0.03	1341 528	878.00
▪		0 - 800	0 - 31	150	6.0	0.01	.0005	20	0.04	1341 532	1165.00
▪		0 - 1000	0 - 39	150	6.0	0.01	.0005	20	0.04	1341 534	1420.00



1998720



1997501



1998501

Accessories

- Battery, 3V-Lithium, CR 2032
- Data cable DATA VARIABLE to USB
- Data cable DATA VARIABLE to RS232
- Data cable DATA VARIABLE to digimatic

Order no.

List price EUR

- 0220 704
- 1998 720
- 1997 501
- 1998 501

- 3.90
- 72.00
- 50.00
- 64.00



0222 / 0223 DIGI-MET® Workshop calipers long version



Model

- Stainless steel
- LCD display 10 mm
- Locking screw
- Knife points
- Factory standard
- Stepped jaws: 30 mm

Functions

- ON / OFF
- Set to zero at any point
- mm / inch switching
- Hold
- Data output Opto RS 232
- PRESET-Function (setting a numerical value)

Delivery

- Wooden case

⏪	🏠	Measuring range		Jaw length		Reading		Error limit	Order no.	List price
		mm	inch	mm	inch	mm	inch	mm		EUR
With knife points, without fine adjustment										
▪		0 - 1500	0 - 59	200	8.0	0.01	.0005	0.1	0222 734	2677.00
▪		0 - 2000	0 - 79	200	8.0	0.01	.0005	0.12	0222 736	3212.00
With knife points, with fine adjustment										
▪		0 - 1500	0 - 59	200	8.0	0.01	.0005	0.1	0223 734	2856.00
▪		0 - 2000	0 - 79	200	8.0	0.01	.0005	0.12	0223 736	3309.00



0996705

0996701

Accessories

	Order no.	List price
		EUR
Battery, 3V-Lithium, CR 2032	0220 704	3.90
Data cable opto to RS232	0996 701	77.00
Data cable opto to USB	0996 705	147.00



1351 DIGI-MET® Workshop calipers with cross points



1351 522

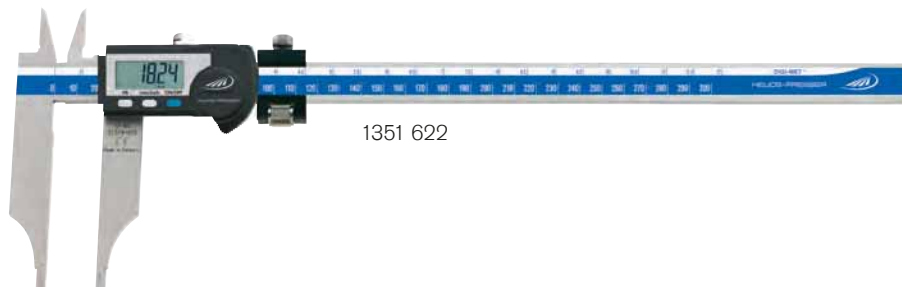

1351 622

Model

- Stainless steel
- DIN 862
- Protection class IP65
- LCD display
- 10 mm with measuring range 300 mm;
- 12.5 mm from measuring range 500 mm
- Locking screw
- Inside cross points
- Three way measurement

Functions

- ON / OFF
- **Quick-Start**
- **Quick-Lock** (key lock)
- Set to zero at any point
- mm / inch switching
- PRESET-Function (setting a numerical value)
- Variable data output RS 232 + Digimatic + USB

Delivery

- Wooden case

Marked	Measuring range		Jaw length		Reading		Error limit	Order no.	List price
	mm	inch	mm	inch	mm	inch	mm		EUR
Without fine adjustment									
	0 - 300	0 - 12	90	3.5	0.01	.0005	0.03	1351 522	554.00
	0 - 500	0 - 20	125	5.0	0.01	.0005	0.03	1351 528	717.00
With fine adjustment									
	0 - 300	0 - 12	90	3.5	0.01	.0005	0.03	1351 622	591.00
	0 - 500	0 - 20	125	5.0	0.01	.0005	0.03	1351 628	784.00



1998720

1997501

1998501

Accessories

	Order no.	List price
Battery, 3V-Lithium, CR 2032	0220 704	3.90
Data cable DATA VARIABLE to USB	1998 720	72.00
Data cable DATA VARIABLE to digimatic	1998 501	64.00
Data cable DATA VARIABLE to RS232	1997 501	50.00



HELIOS · PREISSER

1338 DIGI-MET® Workshop caliper PRISMA



1

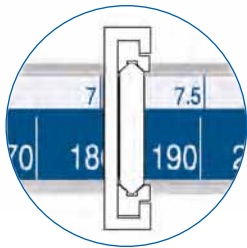
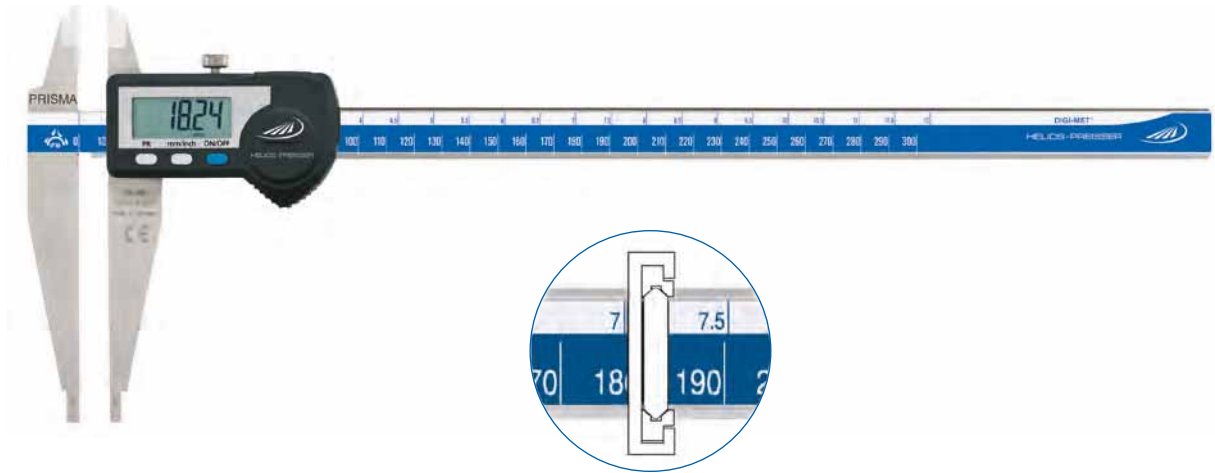

Model

- Double prisma guide with excellent sliding characteristics
- Stainless steel
- Accuracy in accordance to DIN 862
- Protection class IP65
- LCD display 10 mm
- Locking screw
- Knife points
- Stepped jaws for inside measurement 10 mm

Functions

- ON / OFF
- **Quick-Start**
- **Quick-Lock** (key lock)
- Set to zero at any point
- mm / inch switching
- PRESET-Function (setting a numerical value)
- Variable data output RS 232 + Digimatic + USB

Delivery

- Wooden case

Icon	Measuring range		Jaw length		Reading		Error limit	Order no.	List price EUR
	mm	inch	mm	inch	mm	inch	mm		
▪	0 - 300	0 - 12	90	3.5	0.01	.0005	0.03	1338 522	475.00



1998720 1997501 1998501

Accessories

	Order no.	List price EUR
Battery, 3V-Lithium, CR 2032	0220 704	3.90
Data cable DATA VARIABLE to RS232	1997 501	50.00
Data cable DATA VARIABLE to digimatic	1998 501	64.00
Data cable DATA VARIABLE to USB	1998 720	72.00



0228 DIGI-MET® Workshop calipers, lightweight

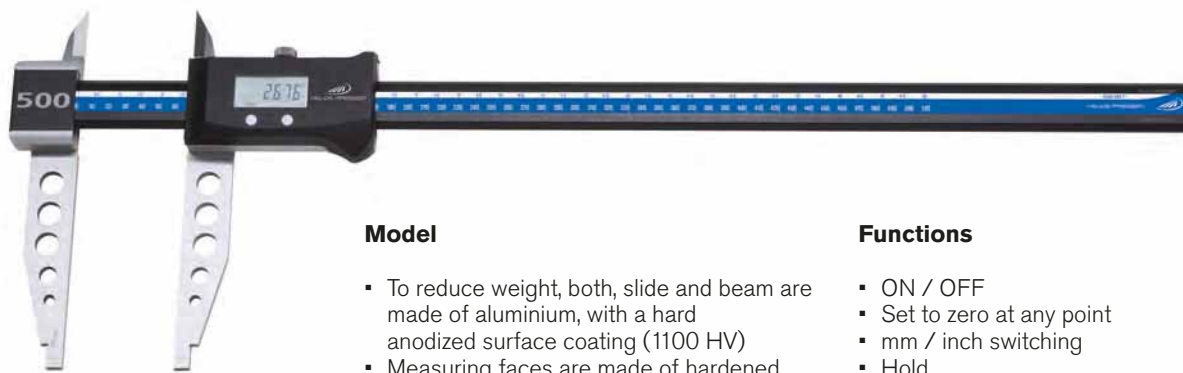

Model

- To reduce weight, both, slide and beam are made of aluminium, with a hard anodized surface coating (1100 HV)
- Measuring faces are made of hardened stainless steel
- Factory standard
- Smooth movement due to the double V-guide
- LCD display
- Locking screw
- Knife points

Functions

- ON / OFF
- Set to zero at any point
- mm / inch switching
- Hold
- PRESET-Function (setting a numerical value)

Delivery

- Wooden case

✕	🏠	Measuring range		Jaw length		Reading		Error limit	Order no.	List price
		mm	inch	mm	inch	mm	inch	mm		EUR
		0 - 300	0 - 12	90	3.5	0.01	.0005	0.03	0228 701	493.00
		0 - 500	0 - 20	150	6.0	0.01	.0005	0.03	0228 702	686.00
		0 - 800	0 - 31	150	6.0	0.01	.0005	0.08	0228 703	964.00
		0 - 1000	0 - 39	150	6.0	0.01	.0005	0.08	0228 704	1137.00
	▪	0 - 1500	0 - 59	150	6.0	0.01	.0005	0.1	0228 724	2869.00
	▪	0 - 2000	0 - 79	150	6.0	0.01	.0005	0.12	0228 726	3410.00

Accessories

	Order no.	List price
		EUR
Battery, 3V-Lithium, CR 2032	0220 704	3.90

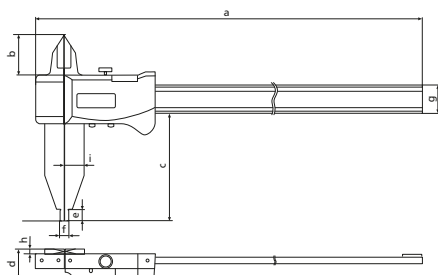

Measuring range	a	b	c	d	e	f	g	h	i
mm									
300	450	33	90	24.5	10	10	25.0	4.5	17.0
500	726	42	150	33.5	15	20	31.9	6.0	29.0
800	1026	42	150	33.5	15	20	31.9	6.0	29.0
1000	1226	42	150	33.5	15	20	31.9	6.0	29.0
1500	1726	42	150	33.5	15	20	31.9	6.0	29.0
2000	2226	42	150	33.5	15	20	31.9	6.0	29.0



HELIOS · PREISSER

1351 DIGI-MET® Caliper with cross points

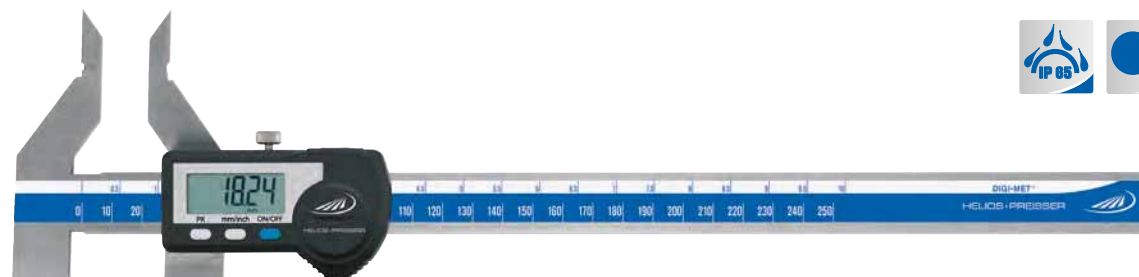

Model

- Stainless steel
- LCD display 10 mm
- Protection class IP65
- Factory standard
- Locking screw
- Inside cross points 55 mm

Functions

- ON / OFF
- **Quick-Start**
- **Quick-Lock** (key lock)
- Set to zero at any point
- mm / inch switching
- PRESET-Function (setting a numerical value)
- Variable data output RS 232 + Digimatic + USB

Delivery

- Wooden case

Measuring range	Jaw length		Reading		Error limit	Order no.	List price	
	mm	inch	mm	inch				mm
0 - 250	0 - 10	80	3.2	0.01	.0005	0.03	1351 920	499.00



1354 DIGI-MET® Caliper with gripper points

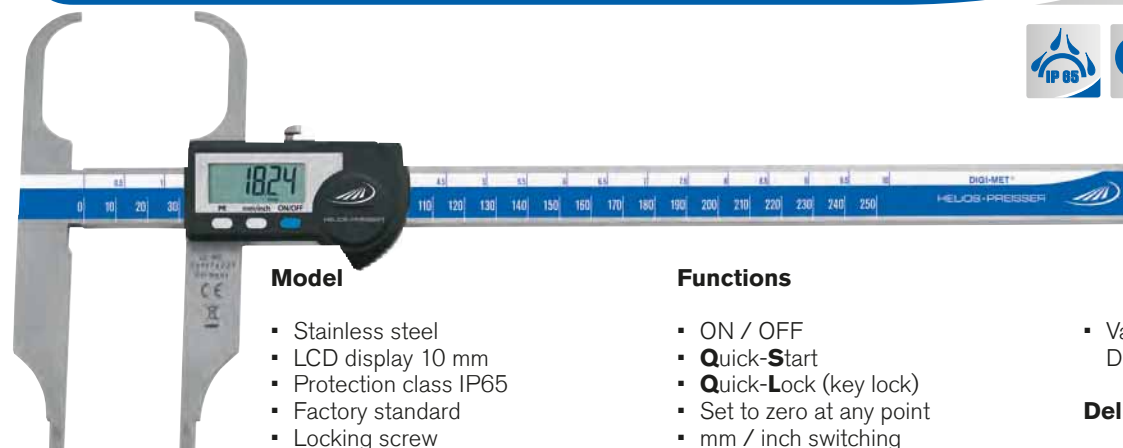

Model

- Stainless steel
- LCD display 10 mm
- Protection class IP65
- Factory standard
- Locking screw
- Gripper points 55 mm

Functions

- ON / OFF
- **Quick-Start**
- **Quick-Lock** (key lock)
- Set to zero at any point
- mm / inch switching
- Hold
- PRESET-Function (setting a numerical value)

- Variable data output RS 232 + Digimatic + USB

Delivery

- Wooden case

Measuring range	Jaw length		Reading		Error limit	Order no.	List price	
	mm	inch	mm	inch				mm
0 - 250	0 - 10	75	3.0	0.01	.0005	0.03	1354 520	590.00



1998720



1997501



1998501

Accessories

Battery, 3V-Lithium, CR 2032

Data cable DATA VARIABLE to RS232

Data cable DATA VARIABLE to digimatic

Data cable DATA VARIABLE to USB

Order no.

0220 704

1997 501

1998 501

1998 720

List price

3.90

50.00

64.00

72.00



1320 DIGI-MET® Pocket caliper with 40 mm inside cross points



DIN
862



Model

- Inductive measuring system, resistant to damp and sweat
- Stainless steel
- LCD display 7.5 mm
- DIN 862
- Locking screw
- Inside cross points
- Four way measurement

Functions

- ON / OFF
- **Quick-Start**
- **Quick-Lock** (key lock)
- Set to zero at any point
- mm / inch switching
- Variable data output
RS 232 + Digimatic + USB

Delivery

- Plastic case

✕	Measuring range		Jaw length		Reading		Error limit	Depth gauge	Order no.	List price
	mm	inch	mm	inch	mm	inch	mm	dia. mm		EUR
▪	0 - 150	0 - 6	40	1.6	0.01	.0005	0.03	round 1.5	1320 518	395.00

Accessories



1998720



1998501



1997501

Battery, 3V-Lithium, CR 2032

Data cable DATA VARIABLE to digimatic

Data cable DATA VARIABLE to RS232

Data cable DATA VARIABLE to USB

Order no.

0220 704

1998 501

1997 501

1998 720

List price

EUR

3.90

64.00

50.00

72.00